

# RODAS

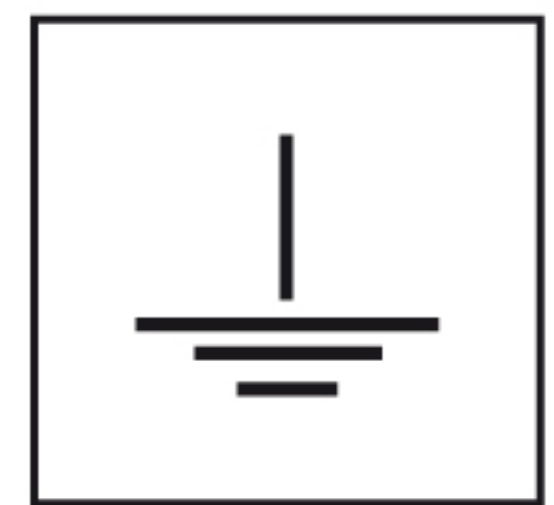

IP  
67



20 Acero Inox 316



230  
V

Máx.  
70 W

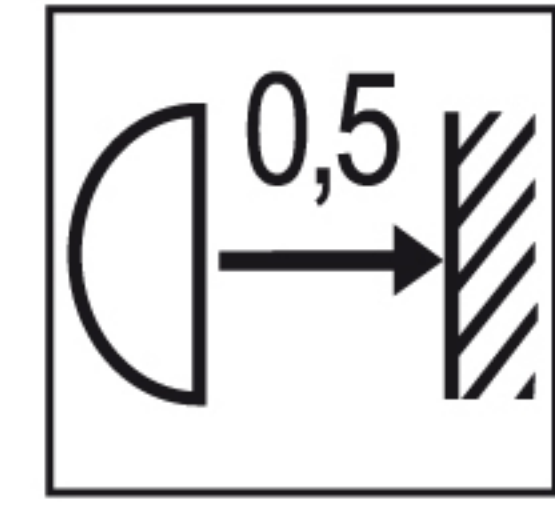
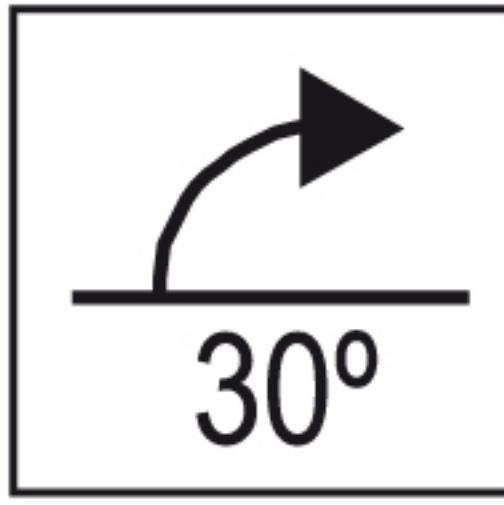
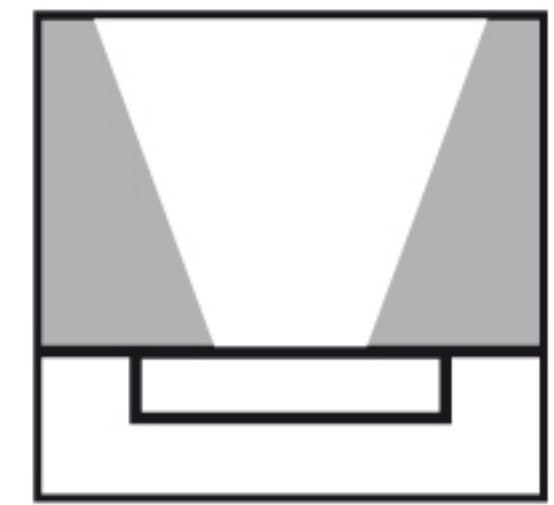
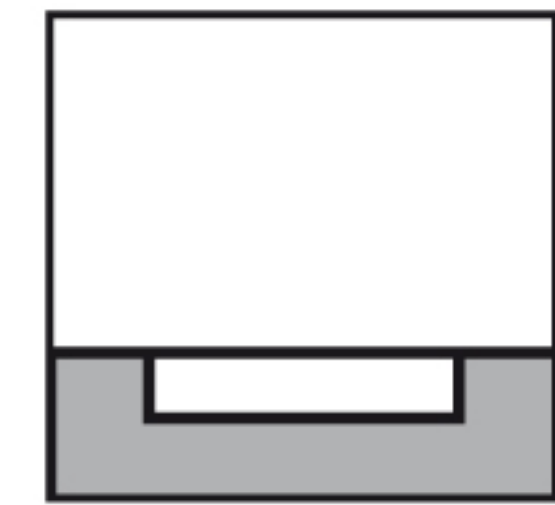
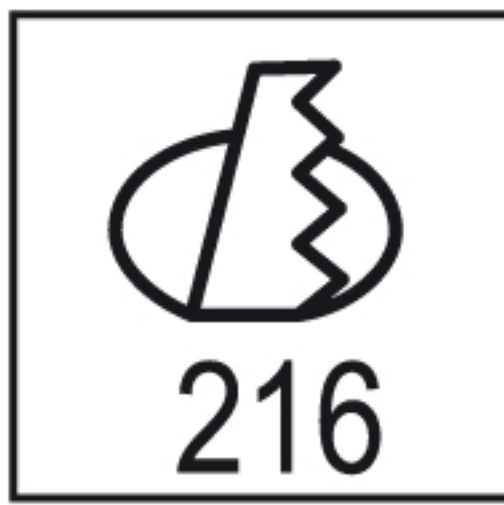

GWT  
850°

IK  
10

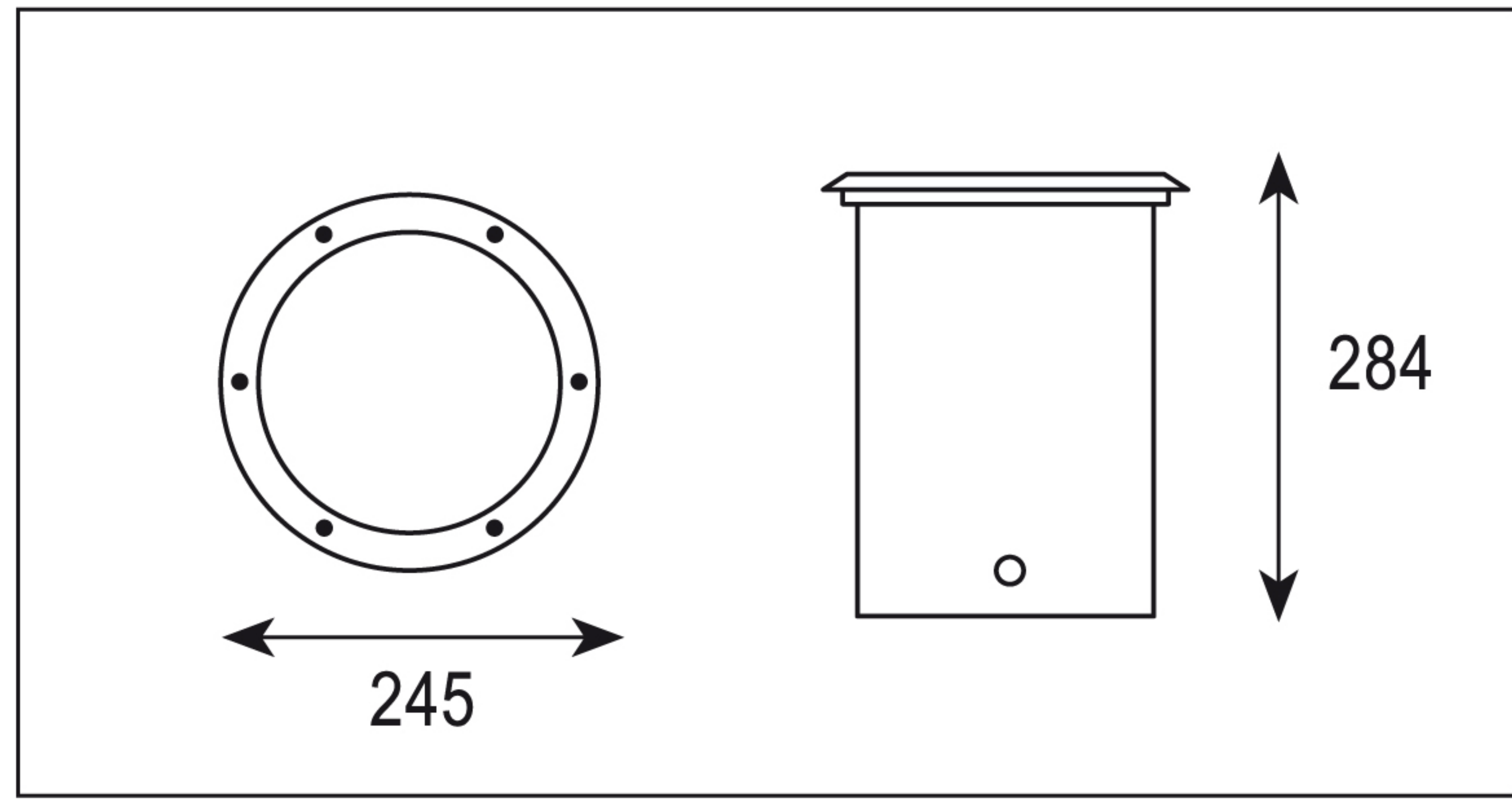

Equipo incluido (EM)